

I PROY
IPRN30W
Proiettore LED 30W



ALTA EFFICIENZA
100 lm/W



GARANTIA



HIGH QUALITY

SCHEMA TECNICA · DATI DEL PRODOTTO

Dati elettrici	
Ingresso	220 ~ 240 Vac
Frequenza di rete	50/60Hz
Potenza	30W
Fattore Potenza	>0.9
N° di LED	48 chips SMD2835
Potenza del LED	0.625W
Classe di protezione IEC	Classe I
Dati fotometrici	
Efficienza luminosa	100lm/W
CRI (Ra)	>80
Flusso luminoso (Nominale / Reale) CCT	3900lm · 3000lm · 6500K · BF 3900lm · 3000lm · 4000K · BN 3900lm · 3000lm · 3000K · BC
Intensità luminosa	857 cd
SDCM deviazione standard corrispondenza cromatica	<3
Angolo di apertura	120°
Temp. Funzionamento	-20°C +45°C
N° commutazioni	30.000
Certificazioni	CE, RoHS
Efficienza energetica	A+
Vita utile	30.000h (L80:B10)
Materiali e caratteristiche fisiche	
Corpo	Lega di alluminio
Diffusore	Vetro temperato
Riflettore	Alluminio
Supporto	Lega di alluminio
Finitura	Nero RAL 7015 Bianco* RAL 9010
Misure in mm (lunghezza x larghezza x altezza)	205 X 33.5 X 190
Peso (g)	796
Caratteristiche	
Grado IP	IP65
Grado IK	IK08
Grado UGR	<22
Opzioni	
Possibilità di regolazione	No
Possibilità di kit di emergenza	No
Possibilità di sensore di movimento	Si (SP65)
Imballi	
Misure dell'imballo	420 X 270 X 185
Peso dell'imballo (kg)	10
Unità (pezzi/scatola)	12 pezzi per scatola

*Finitura bianca disponibile in bianco neutro

Misure in mm

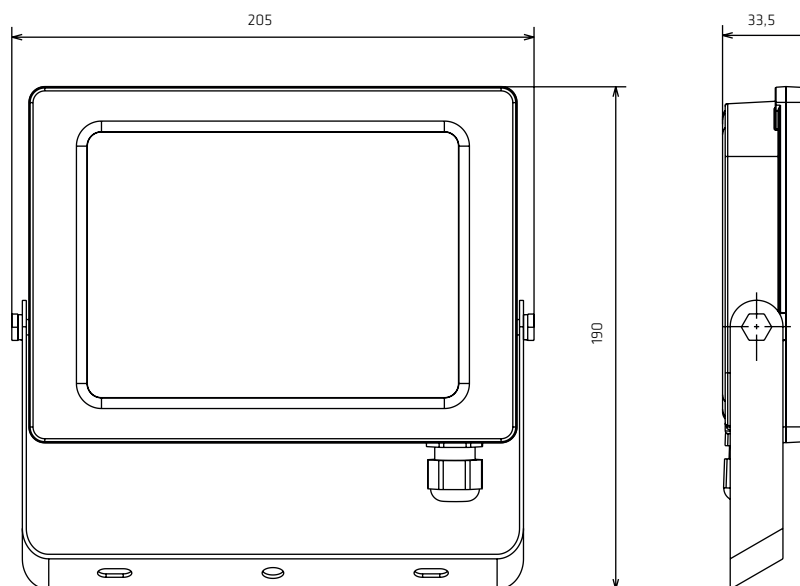



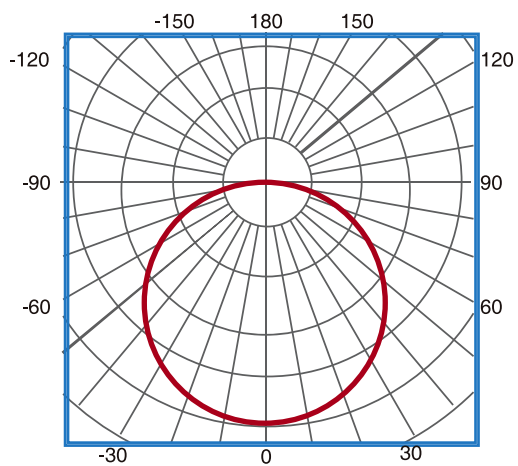

Ottica

Angolo di apertura 120°

H (m)	Diametro (m)	E _{max} (lx)
1	2.98	861.11
2	5.96	215.31
3	8.95	95.68
4	11.93	53.82



Codici

		W				CCT	CRI
IPRN30WBFNE	RAL7015	30 W	3900 lm	3000 lm	120°	BF: 6500K	> 80
IPRN30WBNNE	RAL7015	30 W	3900 lm	3000 lm	120°	BN: 4000K	> 80
IPRN30WBCNE	RAL7015	30 W	3900 lm	3000 lm	120°	BC: 3000K	> 80
IPRN30WBNBL	RAL9016	30 W	3900 lm	3000 lm	120°	BN: 4000K	> 80

Installazione

